

68,5

50

63,5

49 - 54

123 - 142

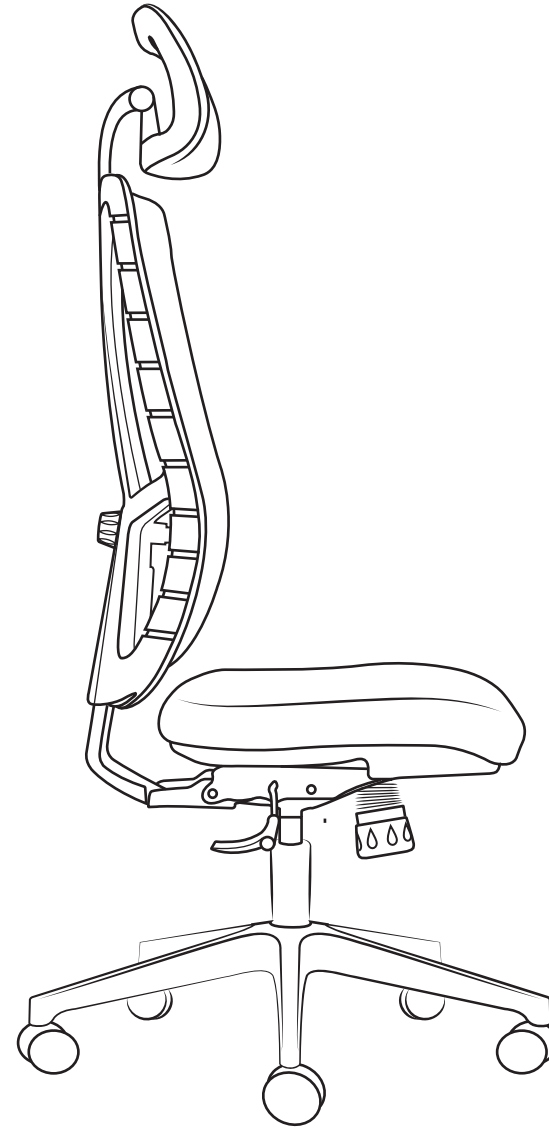
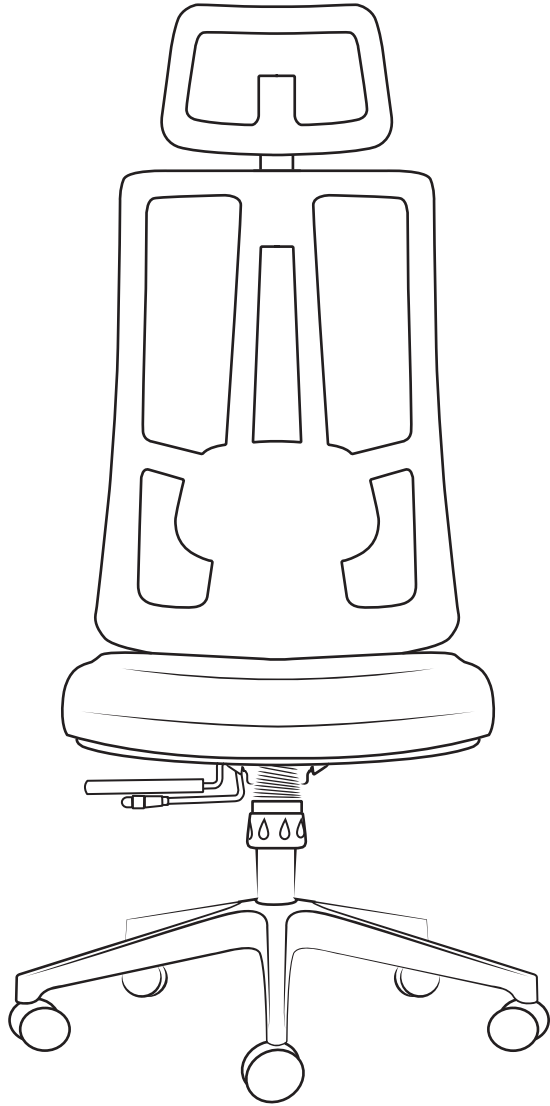

43 - 52,5